

門型部

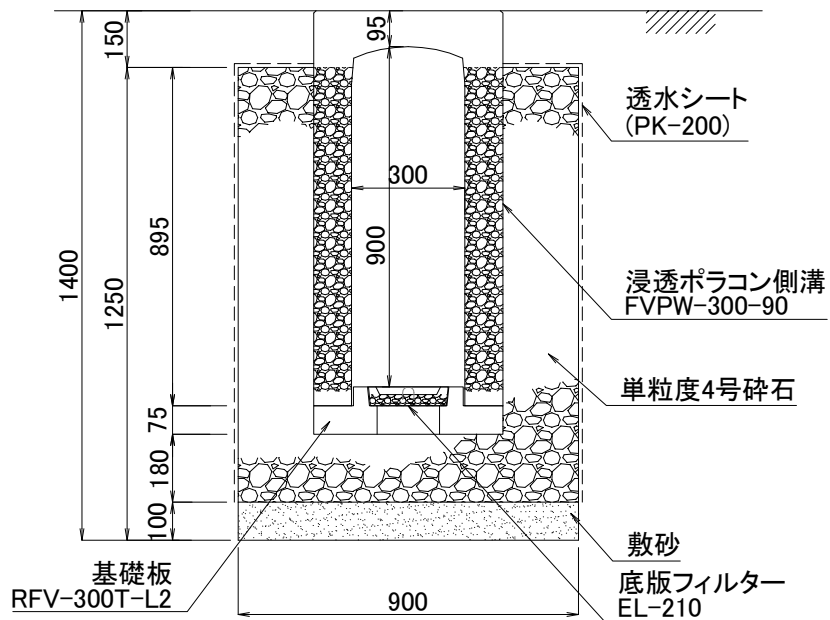

蓋掛部

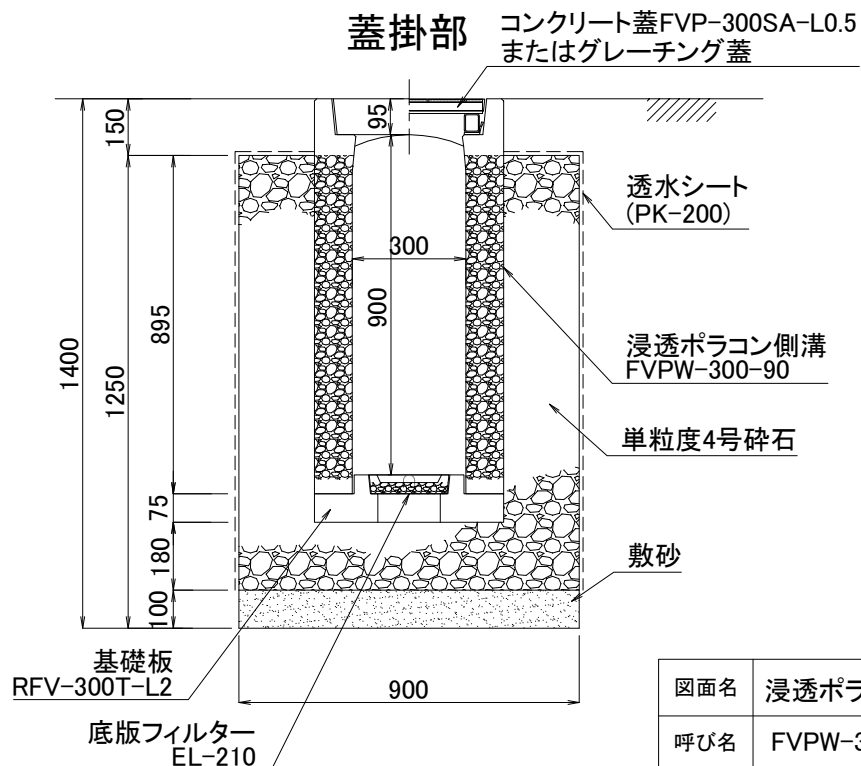

図面名	浸透ポラコン側溝施工断面図		
呼び名	FVPW-300-90	構造	SCALE
		門型両面透水	1/20

関西ポラコン株式会社